

NATURE & SCIENCE MEDICINE

NSM/WALL SIGNS

INNOVATIVE

SIGN SYSTEMS

CONTACT INFO

Michael Snow

msnow@innovativesignsystems.com

760.230.8220

innovativesignsystems.com

NSM/WALL SIGNS
OVERVIEW



DETAILS



CONTRACTOR:
MICHAEL SNOW
msnow@innovativesignsystems.com
760.230.8220
innovativesignsystems.com

CUSTOMER:
**NATURE & SCIENCE
MEDICINE**
Natural Health Clinic

DESCRIPTION:
Front lit sign with TRESPA panel face
and push-through acrylic letters

NOTES:
 INSPECTED AND LABELED IN
ACCORDANCE WITH UL STANDARD
FOR ELECTRIC SIGNS INSTALLED
USING UL LISTED PARTS AND
METHODS OF INSTALLATION.

INNOVATIVE
SIGN SYSTEMS

NSM/WALL SIGNS
TECHNICAL DRAWING

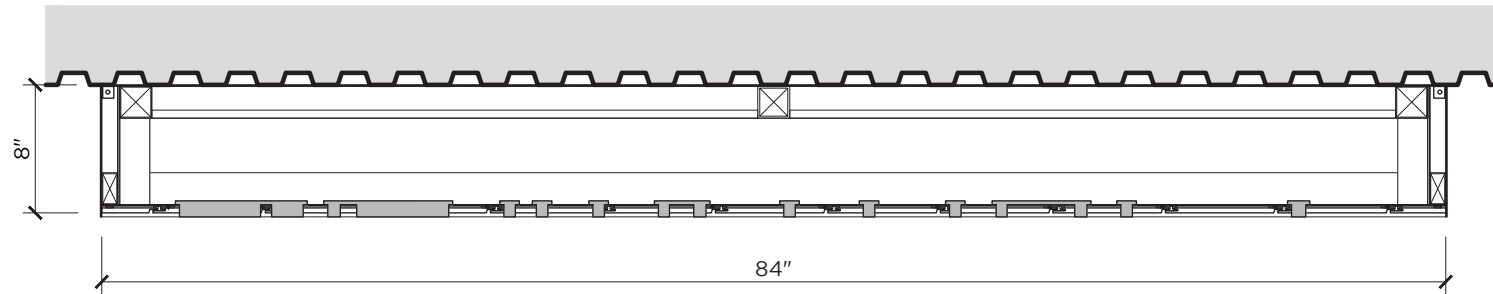

PLAN VIEW
SCALE 1"=1'



FRONT VIEW
SCALE 1"=1'

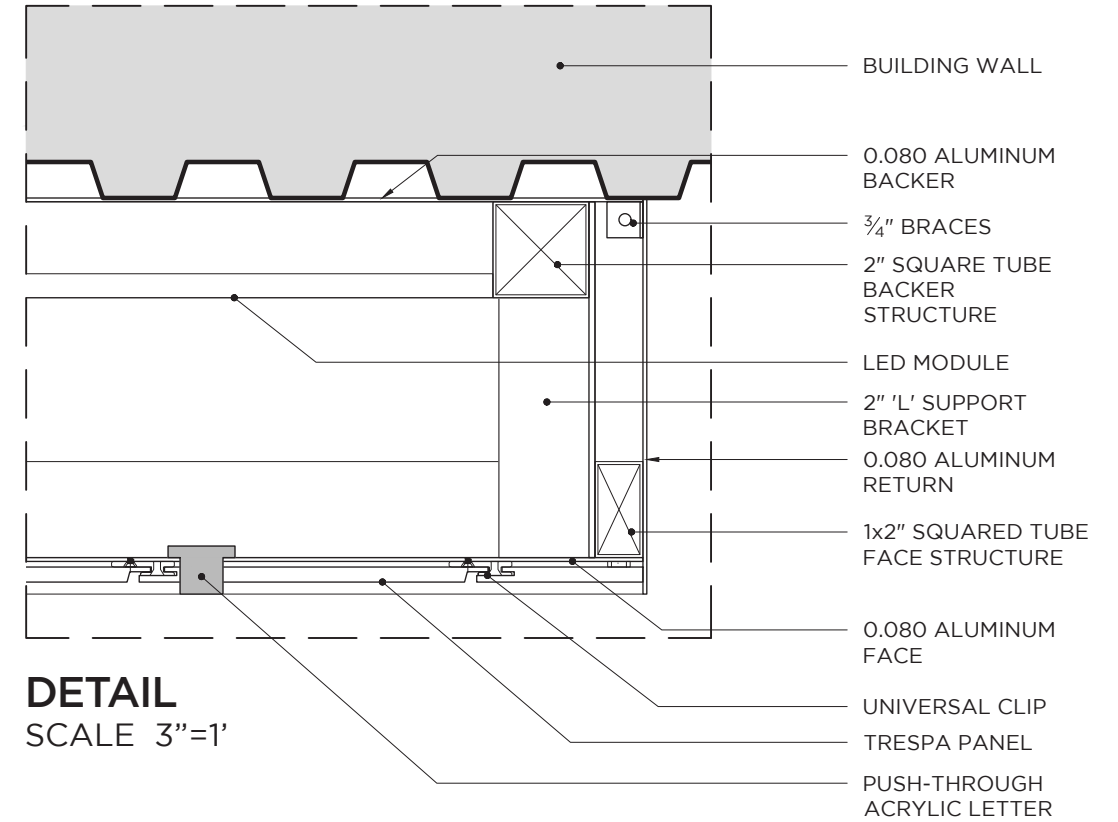

DETAIL
SCALE 3"=1'

CONTRACTOR:
MICHAEL SNOW
msnow@innovativesignsystems.com
760.230.8220
innovativesignsystems.com

CUSTOMER:
**NATURE & SCIENCE
MEDICINE**
Natural Health Clinic

DESCRIPTION:
Front lit sign with TRESPA panel face
and push-through acrylic letters

NOTES:
 INSPECTED AND LABELED IN ACCORDANCE WITH UL STANDARD FOR ELECTRIC SIGNS INSTALLED USING UL LISTED PARTS AND METHODS OF INSTALLATION.

INNOVATIVE
SIGN SYSTEMS

NSM/WALL SIGNS
TECHNICAL DRAWING

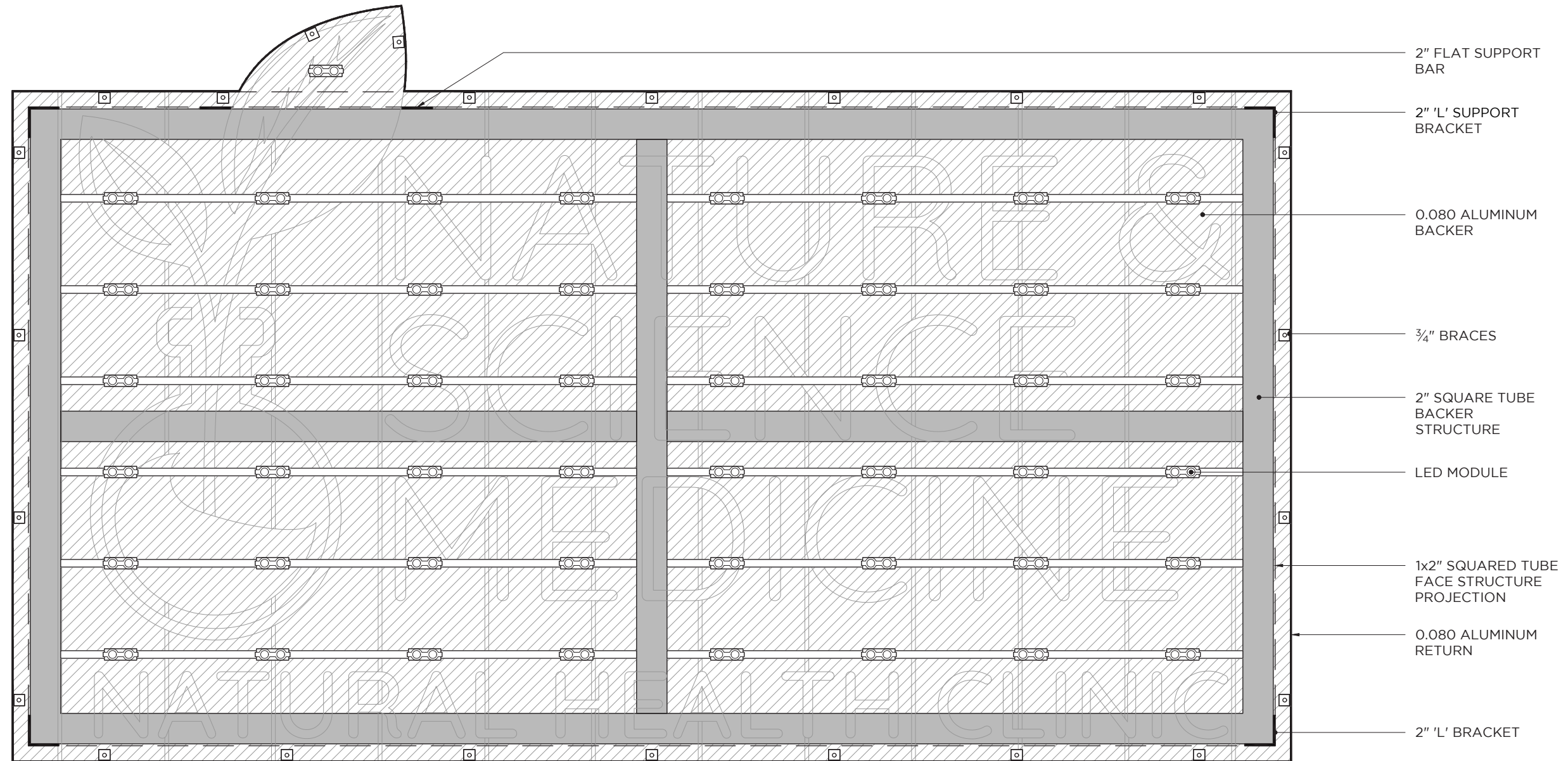

INTERNAL VIEW
 SCALE 1 1/2"=1'

CONTRACTOR:
MICHAEL SNOW
 msnow@innovativesignsystems.com
 760.230.8220
 innovativesignsystems.com

CUSTOMER:
**NATURE & SCIENCE
 MEDICINE**
 Natural Health Clinic

DESCRIPTION:
 Front lit sign with TRESPA panel face
 and push-through acrylic letters

NOTES:



INSPECTED AND LABELED IN ACCORDANCE WITH UL STANDARD FOR ELECTRIC SIGNS INSTALLED USING UL LISTED PARTS AND METHODS OF INSTALATION.



NSM/WALL SIGNS
ASSEMBLY_OVERVIEW

FRONT VIEW

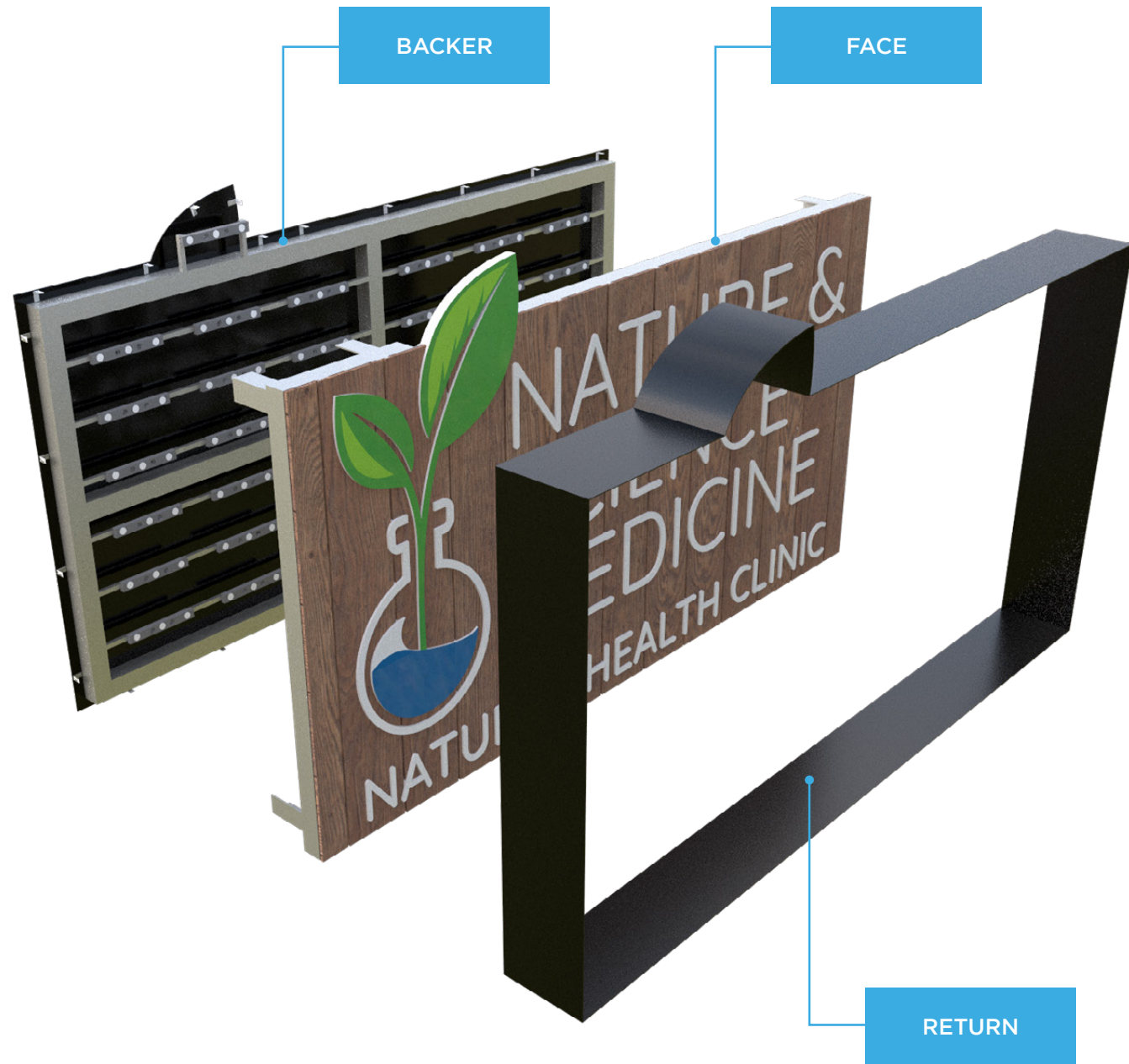

BACK VIEW

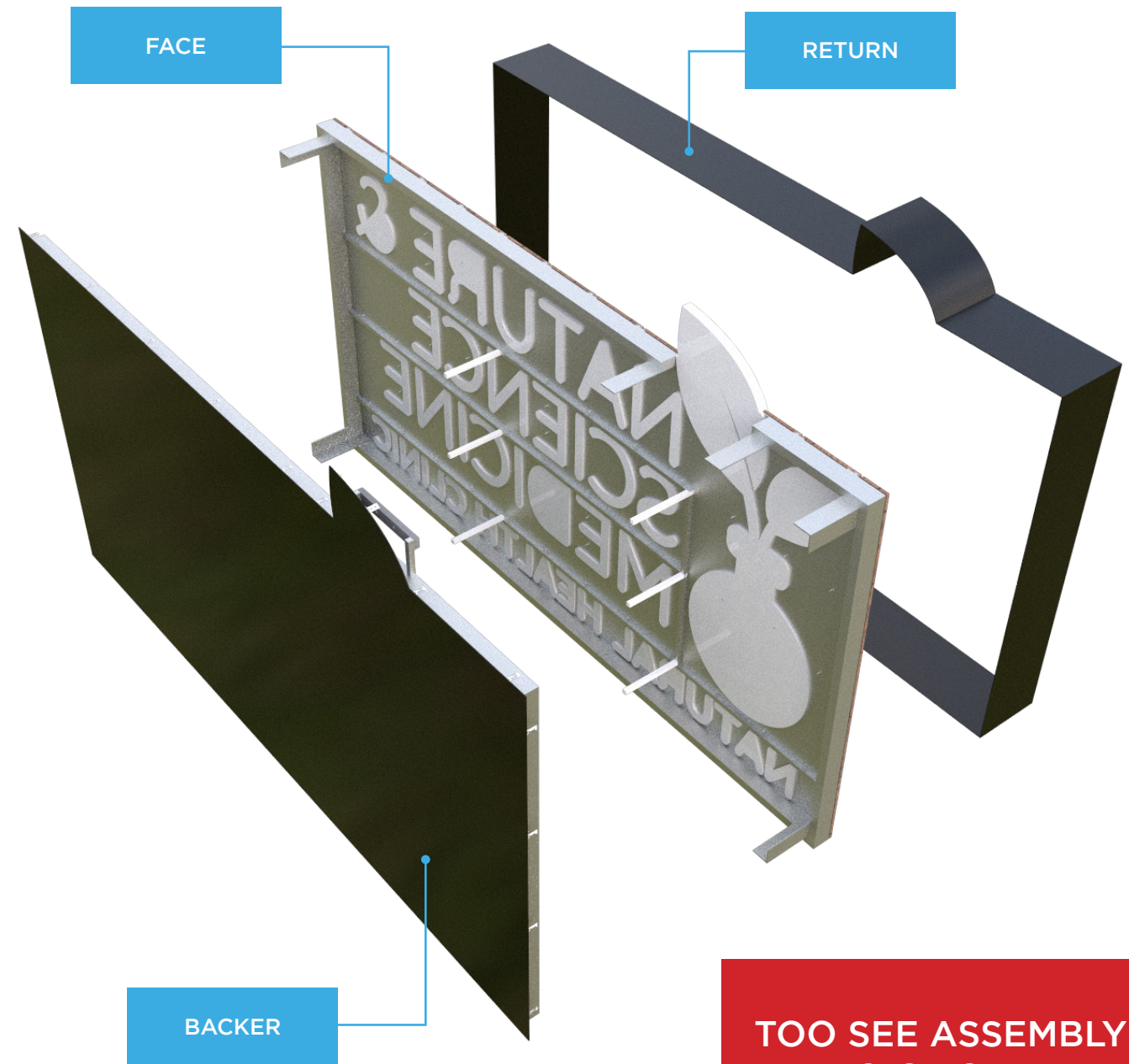

TOO SEE ASSEMBLY
VIDEO CLICK HERE

CONTRACTOR:
MICHAEL SNOW
msnow@innovativesignsystems.com
760.230.8220
innovativesignsystems.com

CUSTOMER:
**NATURE & SCIENCE
MEDICINE**
Natural Health Clinic

DESCRIPTION:
Front lit sign with TRESPA panel face
and push-through acrylic letters

NOTES:
 INSPECTED AND LABELED IN
ACCORDANCE WITH UL STANDARD
FOR ELECTRIC SIGNS INSTALLED
USING UL LISTED PARTS AND
METHODS OF INSTALLATION.

INNOVATIVE
SIGN SYSTEMS

NSM/WALL SIGNS
ASSEMBLY_FRONT VIEW

BACKER

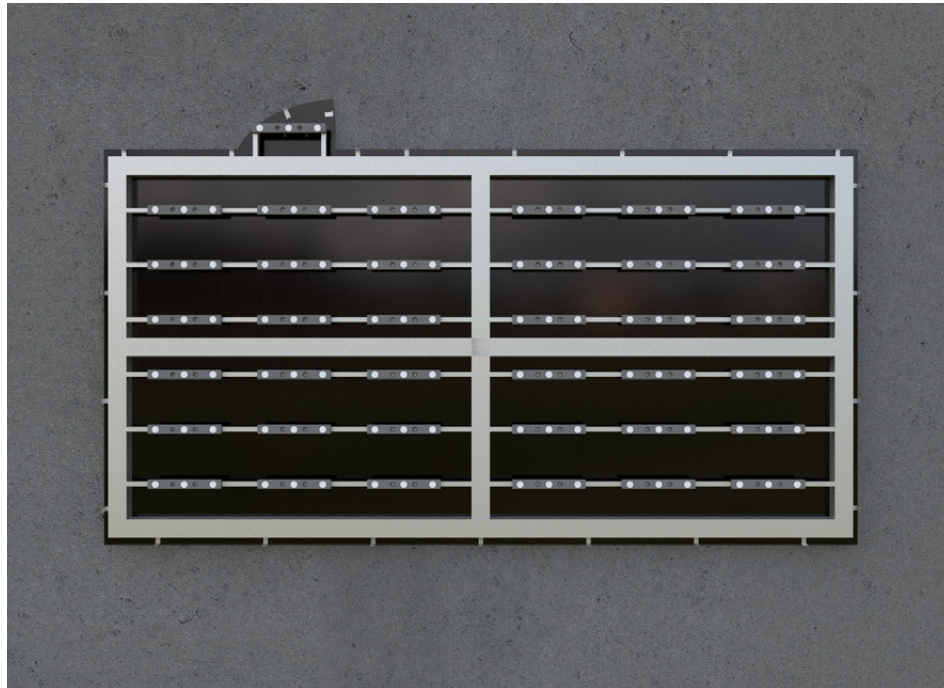

STRUCTURE

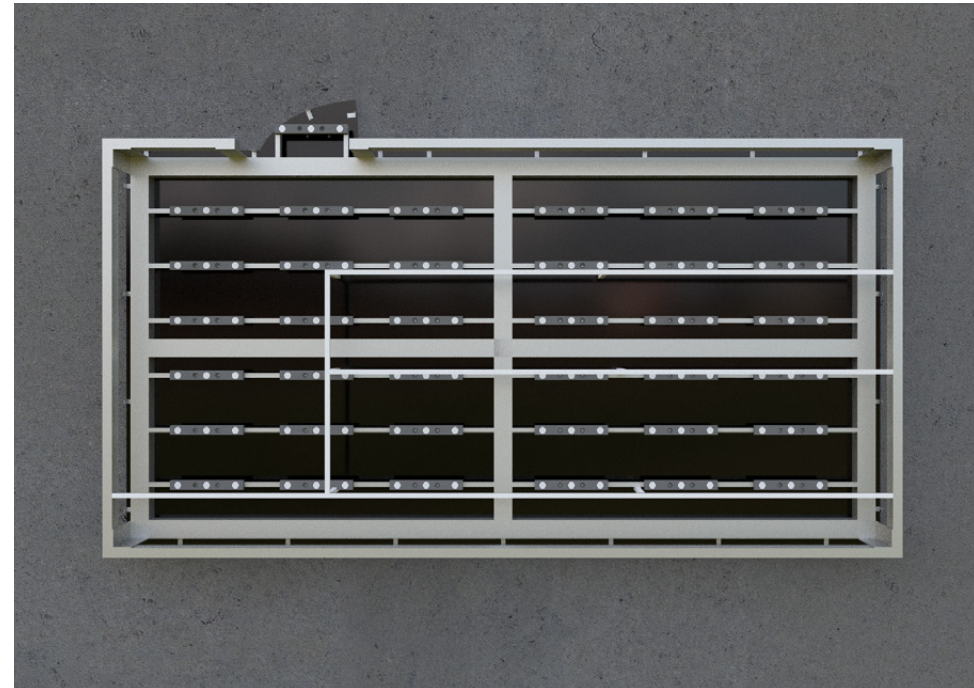

ACRYLIC



ALUMINUM



TRESPA



RETURN



CONTRACTOR:
MICHAEL SNOW
msnow@innovativesignsystems.com
760.230.8220
innovativesignsystems.com

CUSTOMER:
**NATURE & SCIENCE
MEDICINE**
Natural Health Clinic

DESCRIPTION:
Front lit sign with TRESPA panel face
and push-through acrylic letters

NOTES:
 INSPECTED AND LABELED IN
ACCORDANCE WITH UL STANDARD
FOR ELECTRIC SIGNS INSTALLED
USING UL LISTED PARTS AND
METHODS OF INSTALLATION.

INNOVATIVE
SIGN SYSTEMS

NSM/WALL SIGNS
ASSEMBLY_PERSPECTIVE

BACKER



STRUCTURE

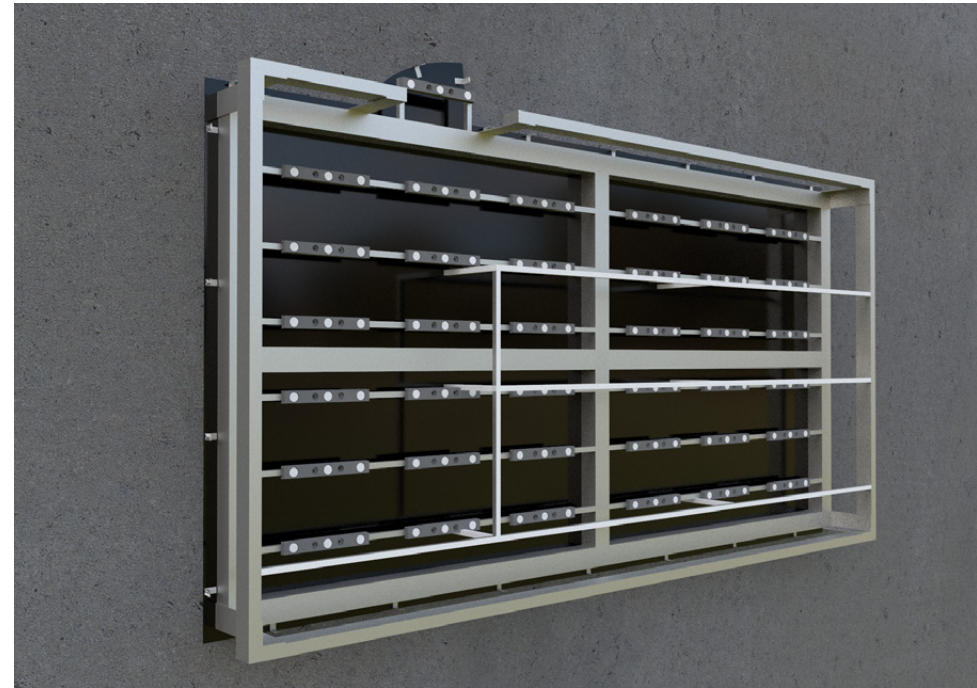

ACRYLIC



ALUMINUM



TRESPA



RETURN



CONTRACTOR:
MICHAEL SNOW
msnow@innovativesignsystems.com
760.230.8220
innovativesignsystems.com

CUSTOMER:
**NATURE & SCIENCE
MEDICINE**
Natural Health Clinic

DESCRIPTION:
Front lit sign with TRESPA panel face
and push-through acrylic letters

NOTES:
 INSPECTED AND LABELED IN
ACCORDANCE WITH UL STANDARD
FOR ELECTRIC SIGNS INSTALLED
USING UL LISTED PARTS AND
METHODS OF INSTALLATION.

INNOVATIVE
SIGN SYSTEMS

THANK YOU!